

**S250 PROJECT OUT PERFORMANCE DATA:
AAMA/WDMA/CSA 101/I.S.2/A440-08
AAMA/WDMA/CSA 101/I.S.2/A440-11**

Rating	CW-PG60-AP
Air Infiltration	<0.15 cfm/ft @ 1.57 psf
Water Resistance	**0 leakage at 12.0 lb
Structural Performance	+/- 90.00 psf
Thermally Broken	Yes
Frame Depth	2-1/2"
Infill Options	Maximum 1"

**** Optional Water 0 leakage at 15.0 lb**

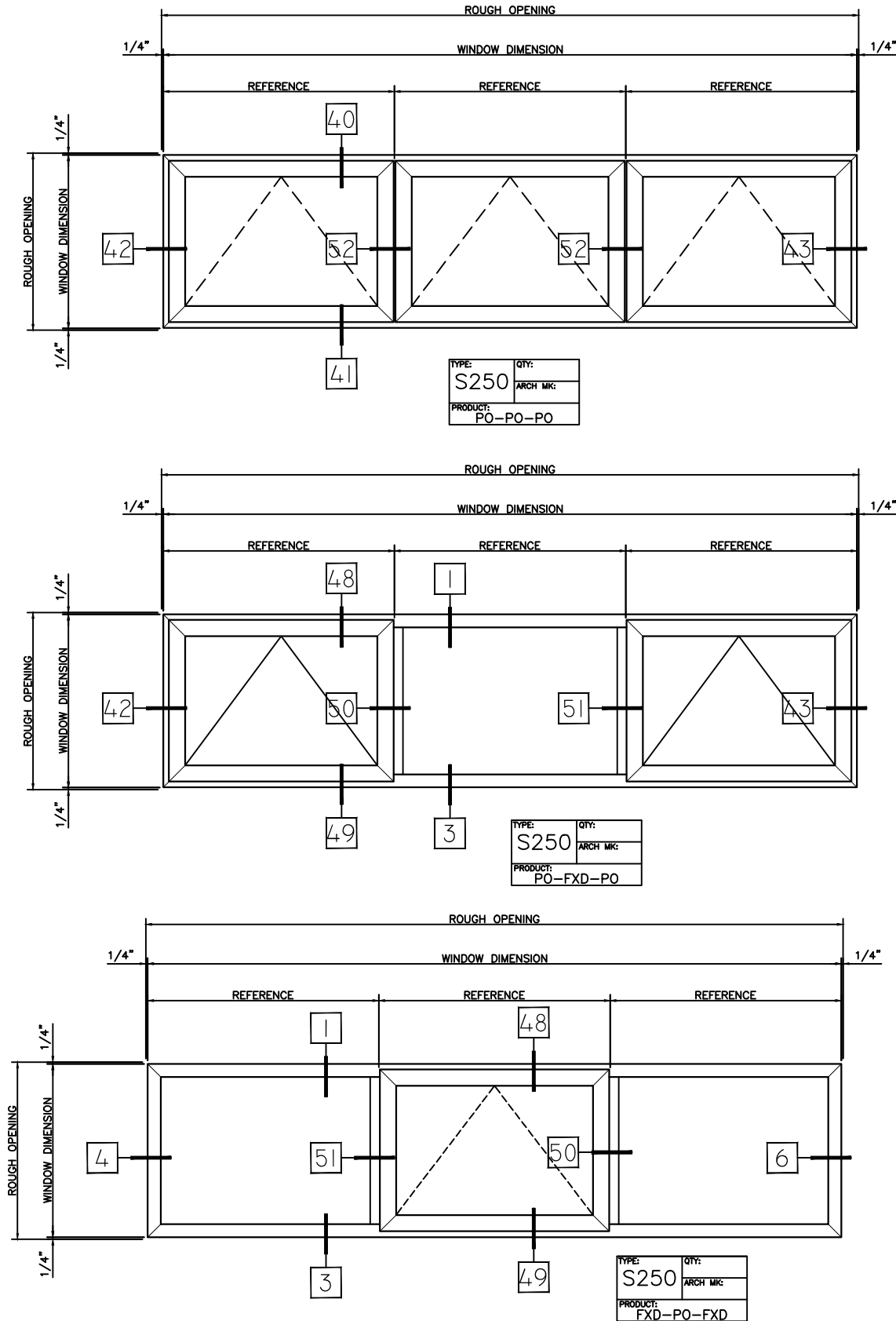

HALF SCALE DETAILS

WINTECH

P.O. BOX 480
MONETT, MO 65708-0480

P: 417-235-7821
F: 417-737-7140
www.wintechinc.com

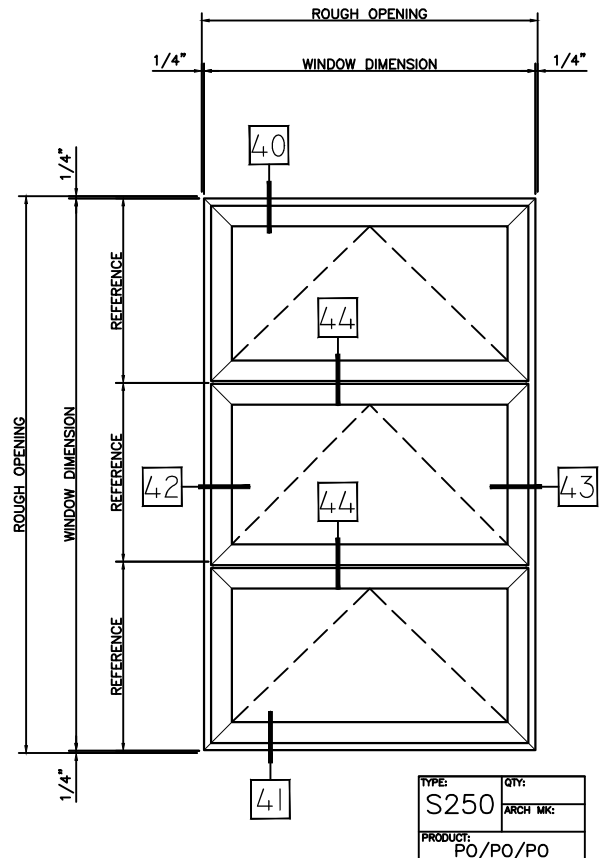
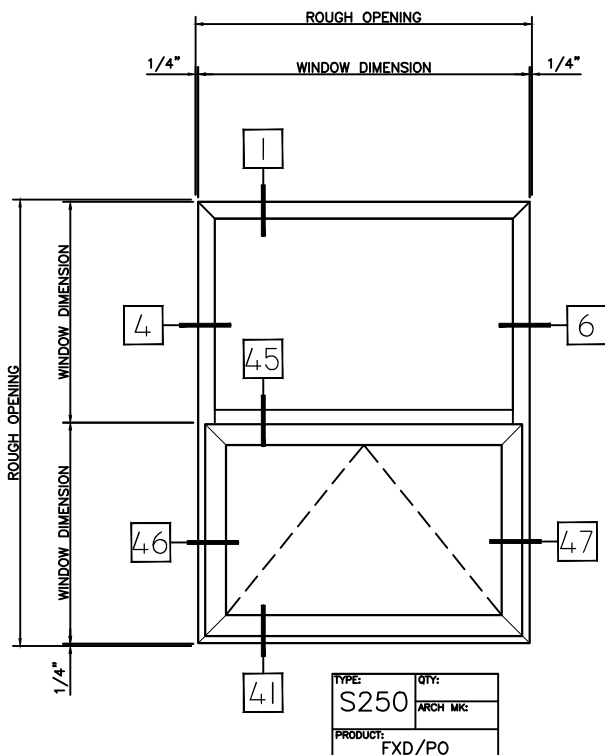
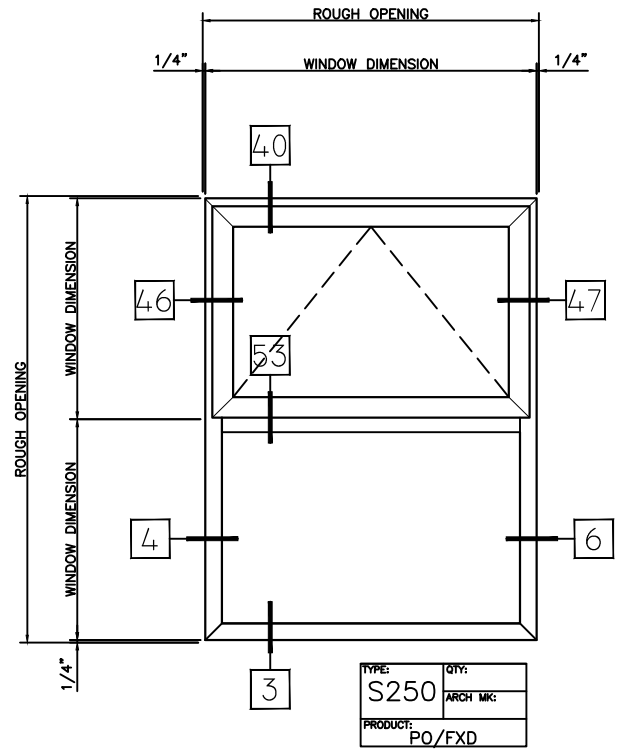
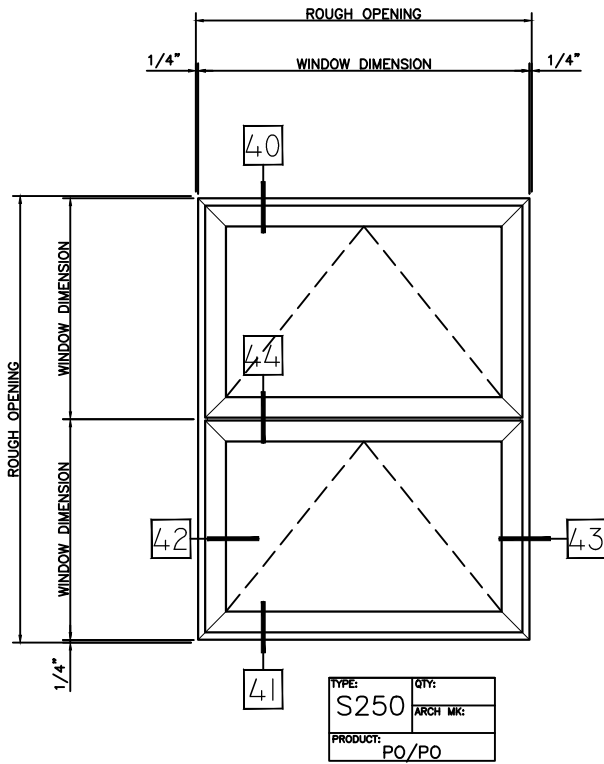

HALF SCALE DETAILS

WINTECH

P.O. BOX 480
 MONETT, MO 65708-0480

P: 417-235-7821
 F: 417-737-7140
 www.wintechinc.com

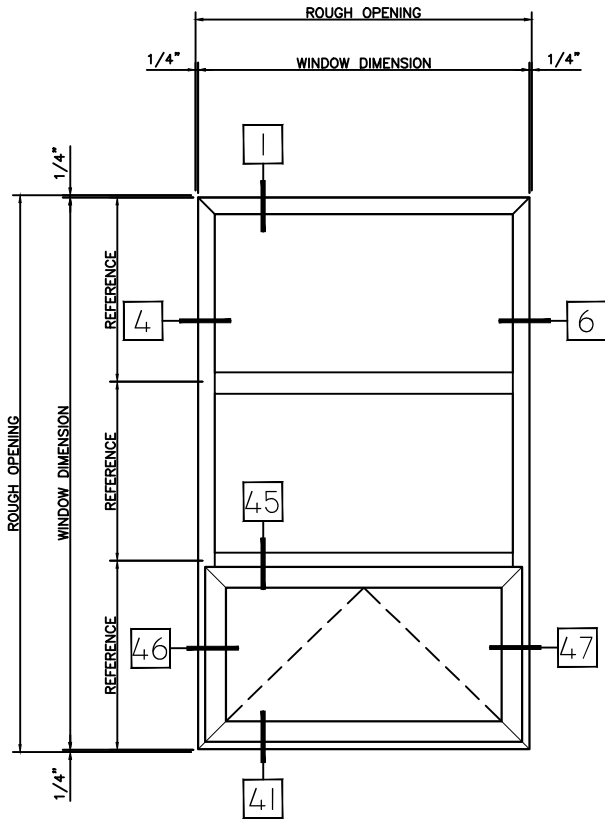

TYPE:	QTY:
S250	
ARCH MK:	
PRODUCT:	
FXD/FXD/PO	

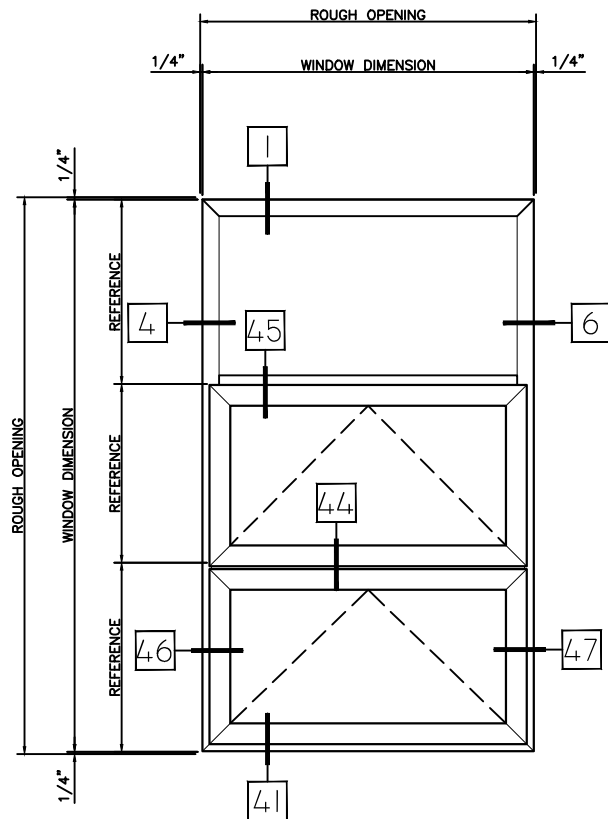

TYPE:	QTY:
S250	
ARCH MK:	
PRODUCT:	
FXD/PO/PO	

HALF SCALE DETAILS

WINTECH

P.O. BOX 480
 MONETT, MO 65708-0480

P: 417-235-7821
 F: 417-737-7140
 www.wintechinc.com

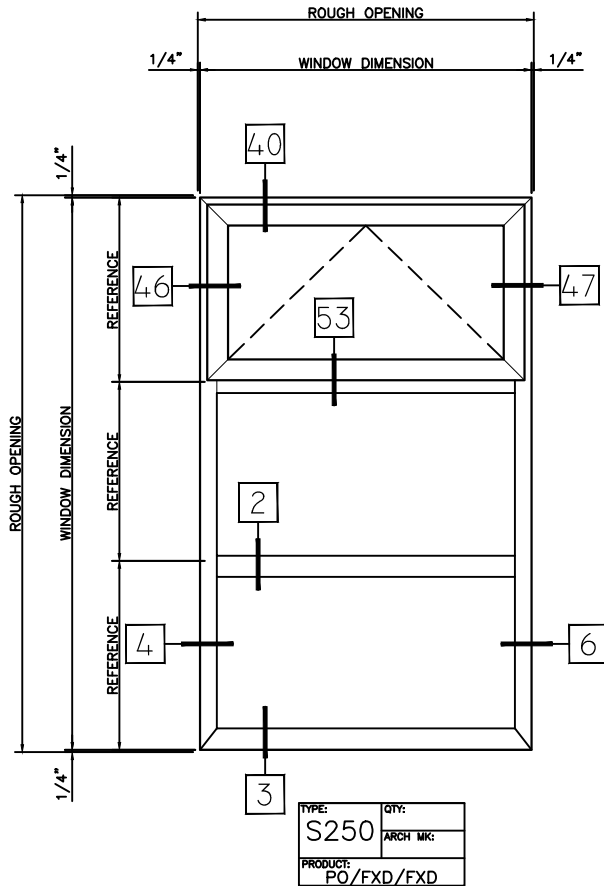
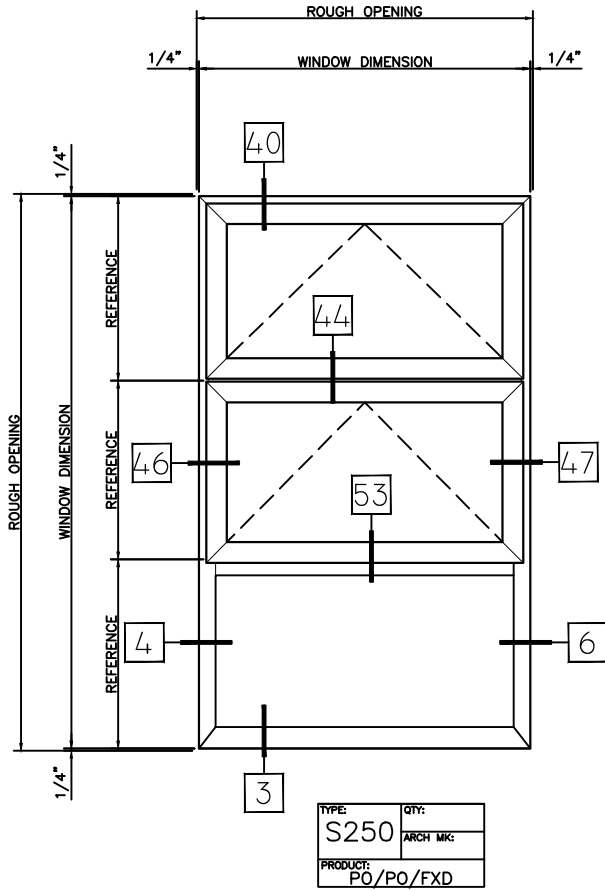

HALF SCALE DETAILS

WINTeCH

P.O. BOX 480
 MONETT, MO 65708-0480

P: 417-235-7821
 F: 417-737-7140
 www.wintechinc.com

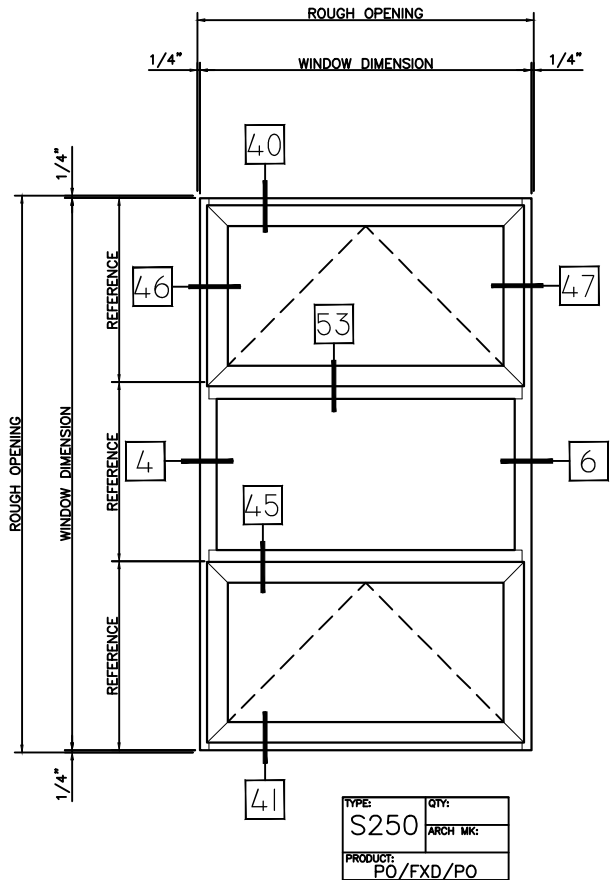
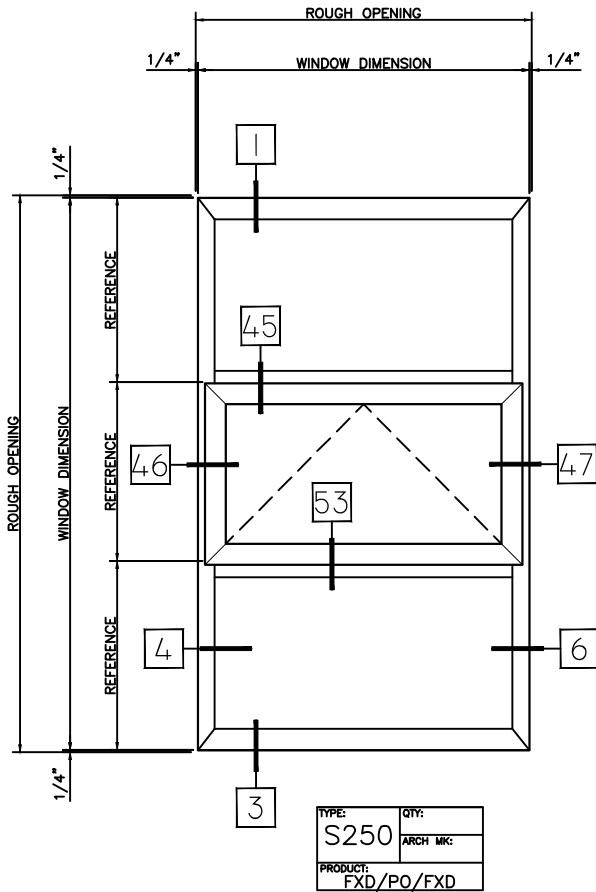

HALF SCALE DETAILS

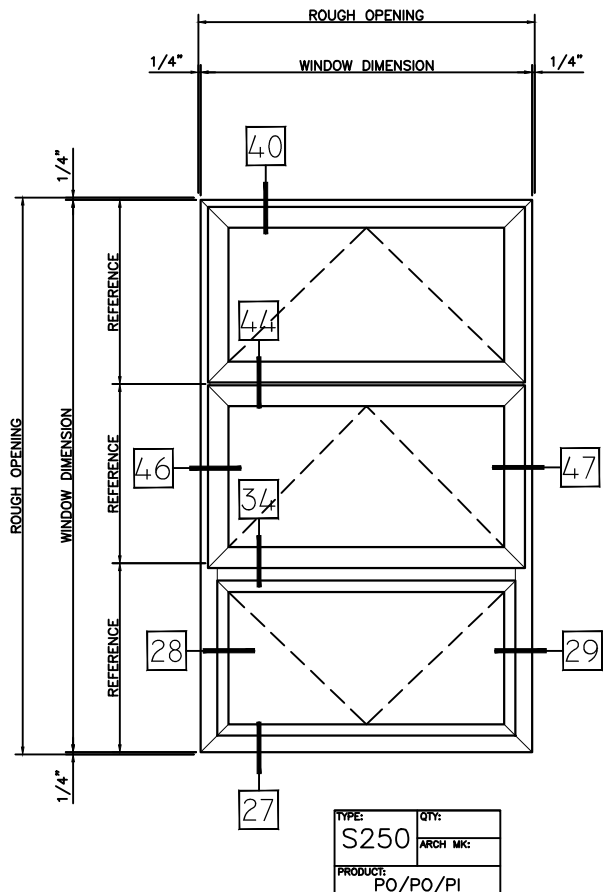
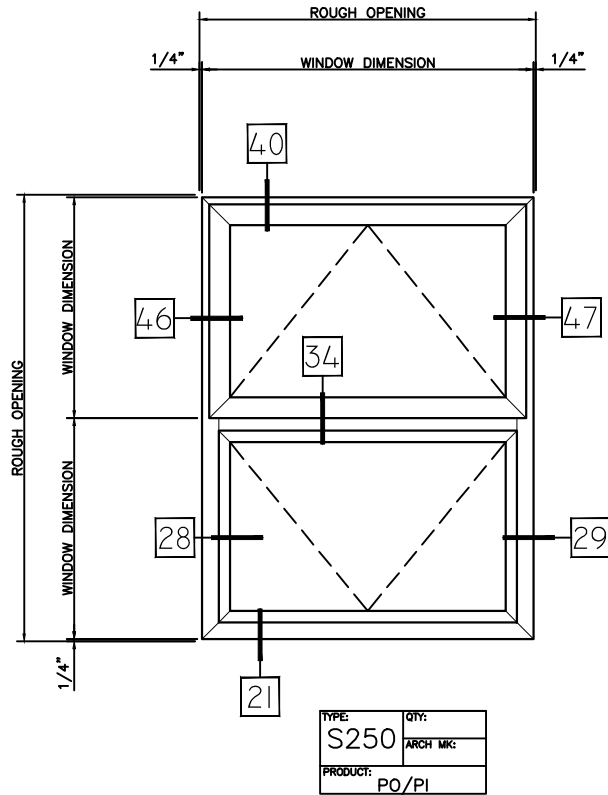

HALF SCALE DETAILS

WINTECH

P.O. BOX 480
 MONETT, MO 65708-0480

P: 417-235-7821
 F: 417-737-7140
 www.wintechinc.com

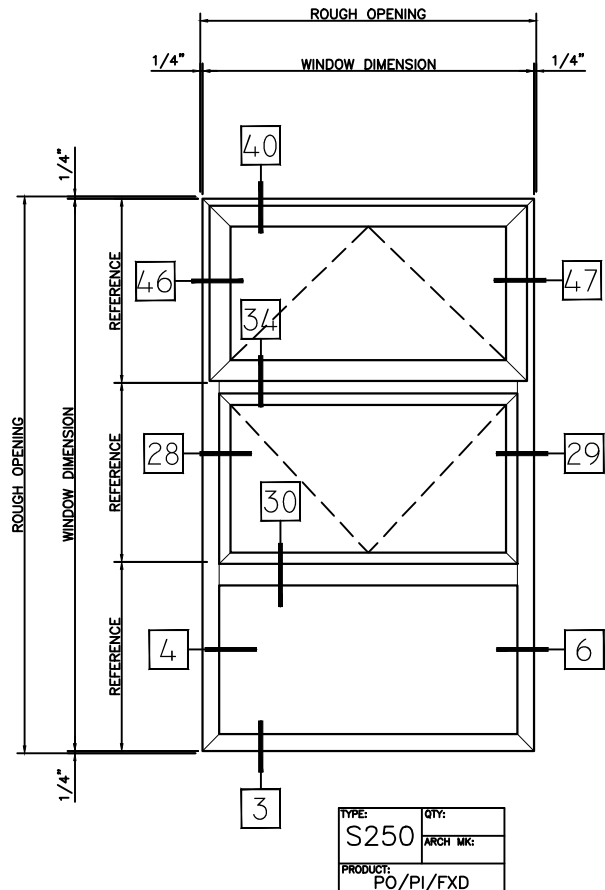
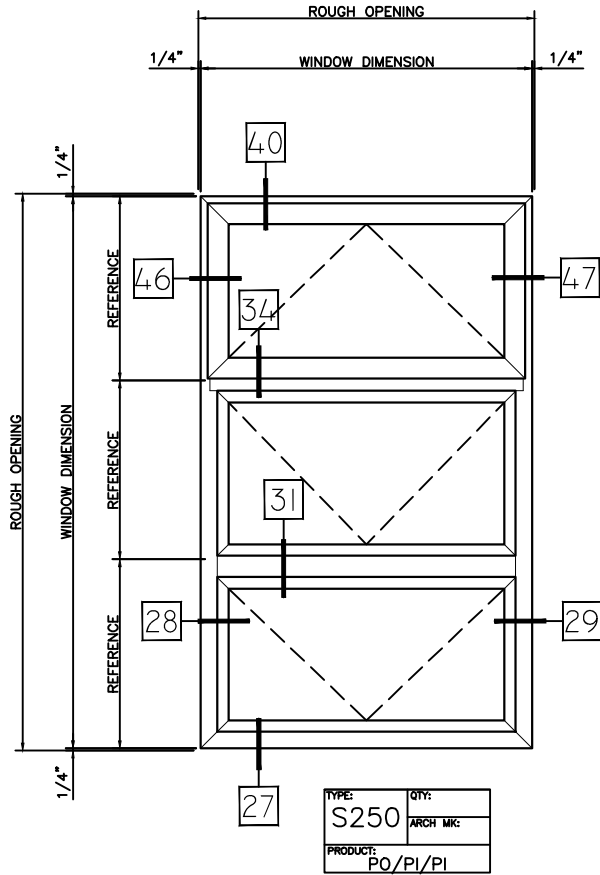

HALF SCALE DETAILS

WINTeCH

P.O. BOX 480
 MONETT, MO 65708-0480

P: 417-235-7821
 F: 417-737-7140
 www.wintechinc.com

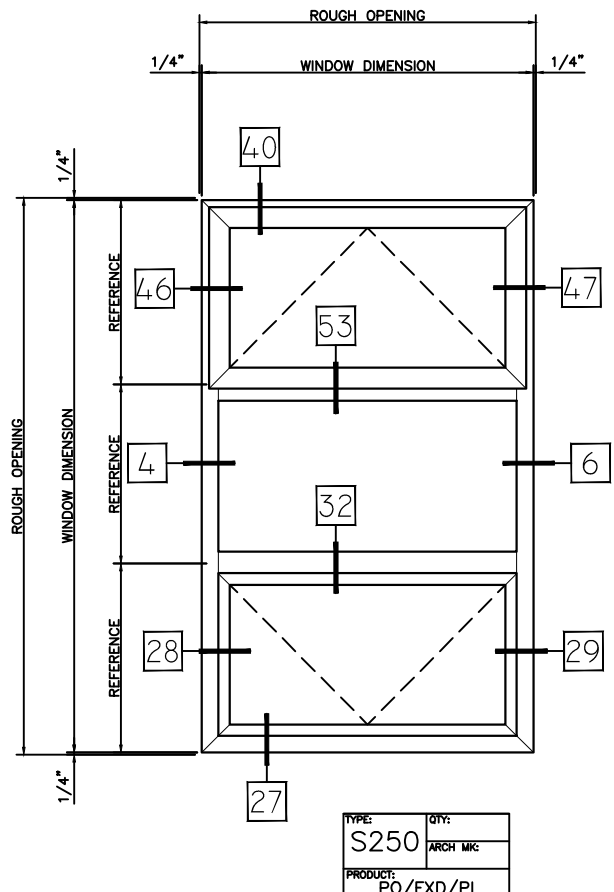
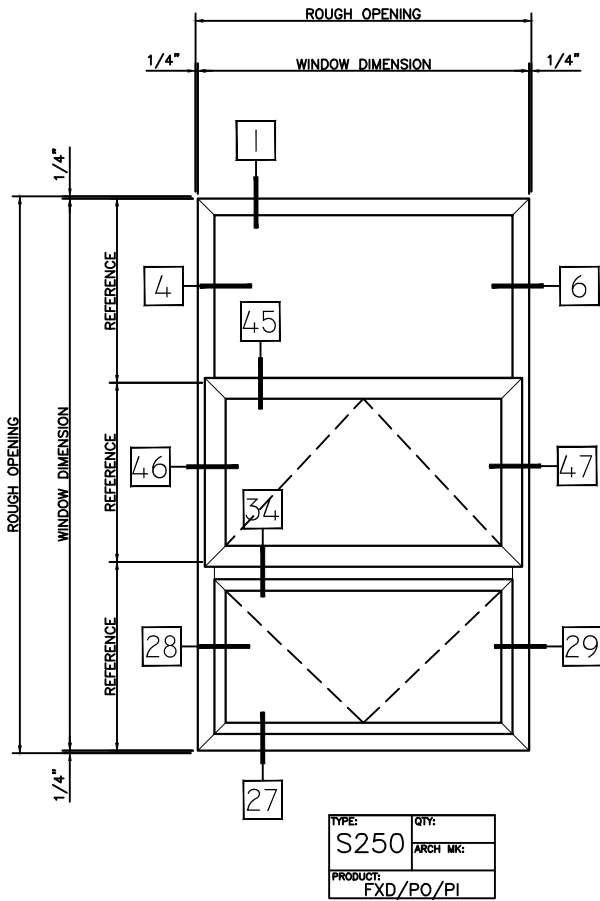

HALF SCALE DETAILS

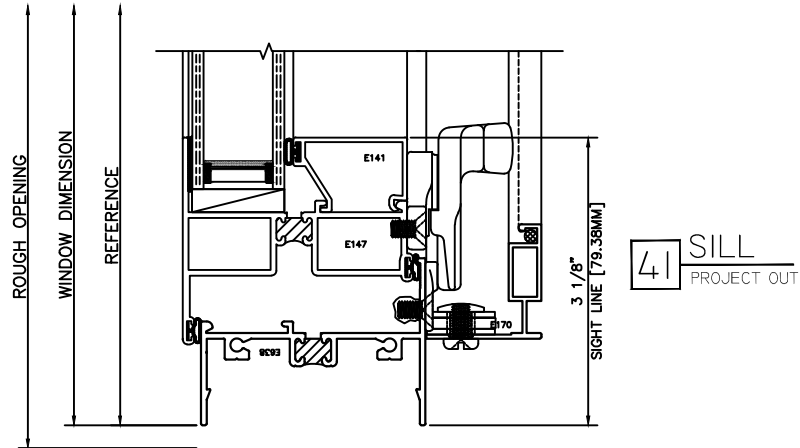
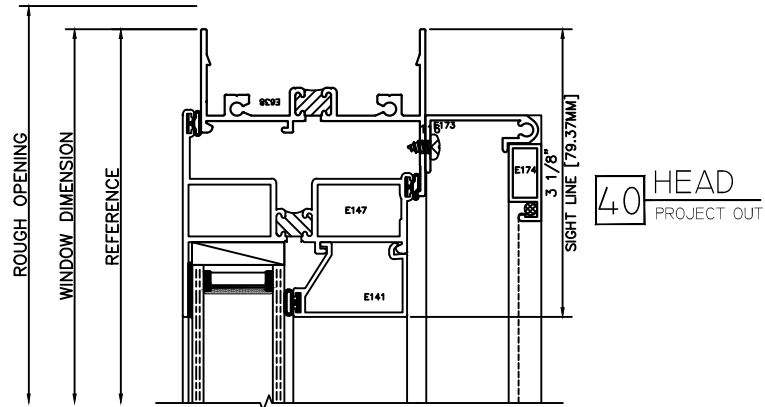

42 JAMB
PROJECT OUT

43 JAMB
PROJECT OUT

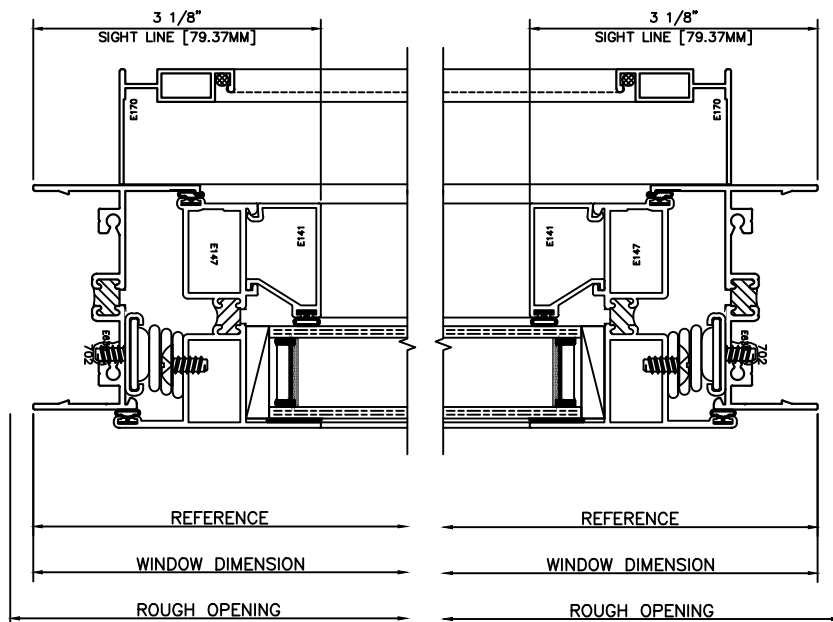

HALF SCALE DETAILS

WINTECH

P.O. BOX 480
MONETT, MO 65708-0480

P: 417-235-7821
F: 417-737-7140
www.wintechinc.com

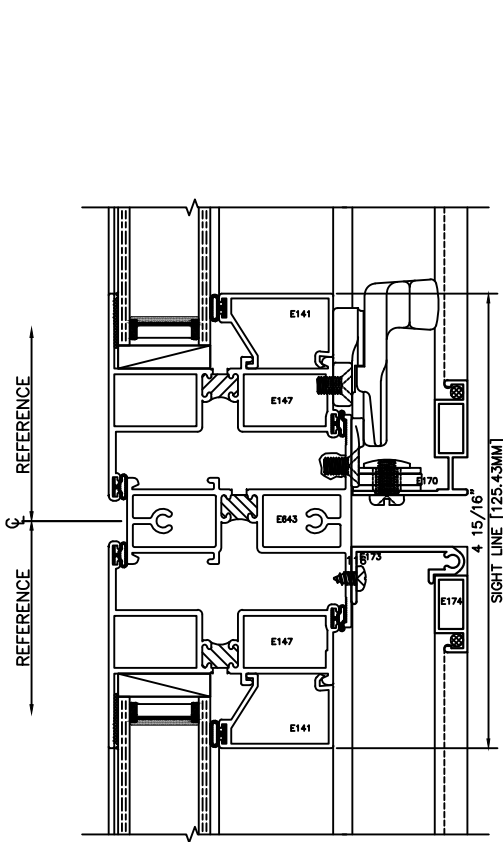

44 MTG RAIL
PO/PO

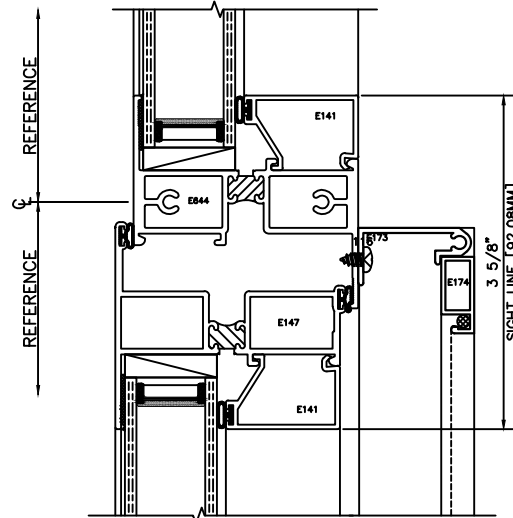

45 MTG RAIL
FXD/PO

46 JAMB
PROJECT OUT

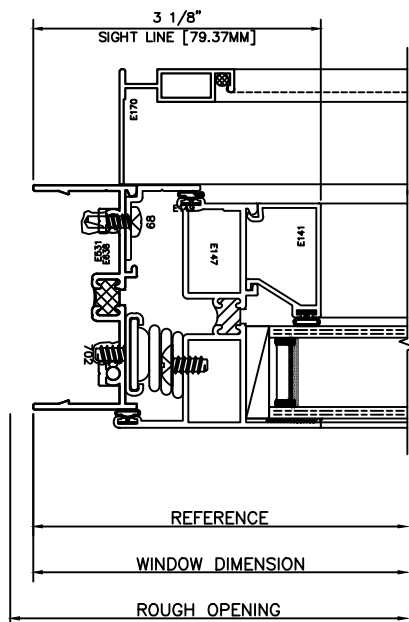

47 JAMB
PROJECT OUT

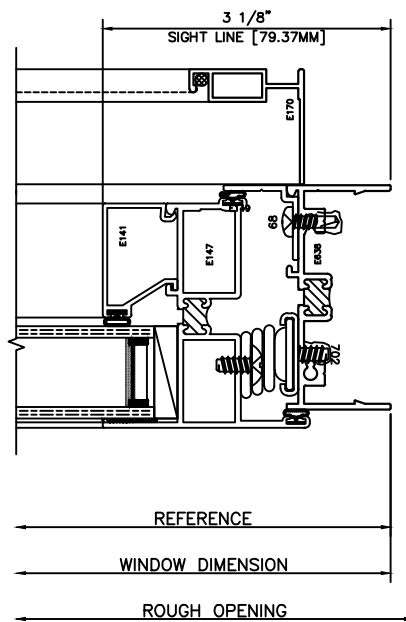

HALF SCALE DETAILS

WINTECH

P.O. BOX 480
 MONETT, MO 65708-0480

P: 417-235-7821
 F: 417-737-7140
 www.wintechinc.com

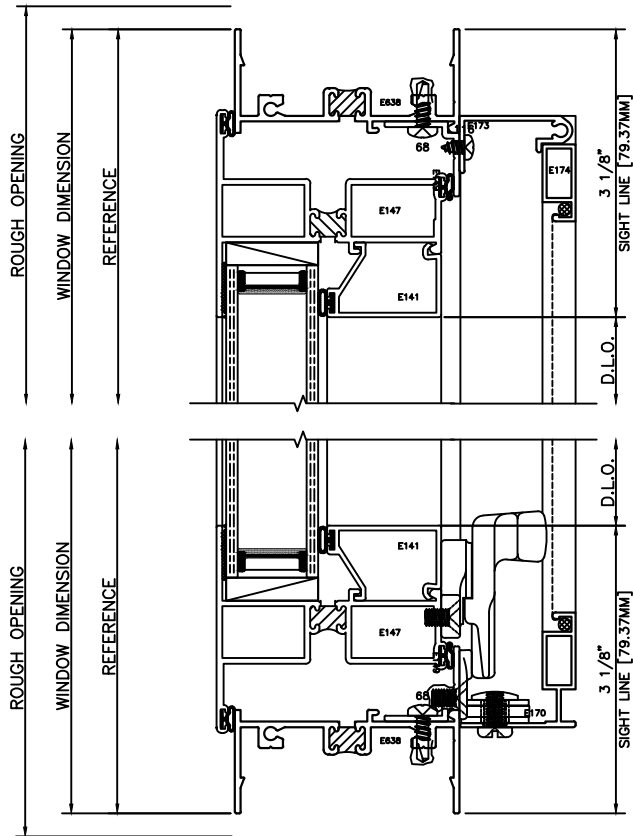

48 HEAD
 PROJECT OUT

49 SILL
 PROJECT OUT

50 MTG RAIL
 PO-FXD

51 MTG RAIL
 FXD-PO

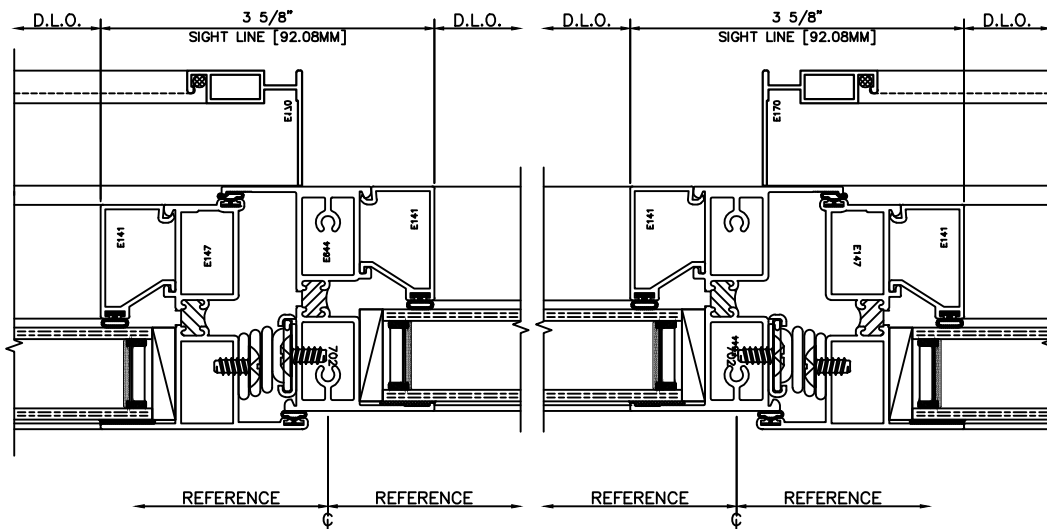

HALF SCALE DETAILS

WINTTECH

P.O. BOX 480
MONETT, MO 65708-0480

P: 417-235-7821
F: 417-737-7140
www.winttechinc.com

52 MTG RAIL PO/PO

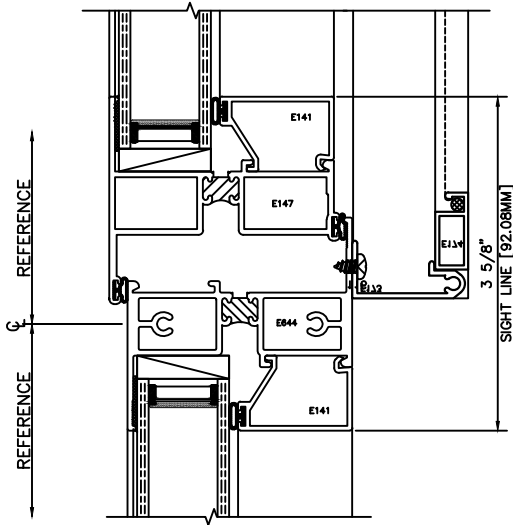
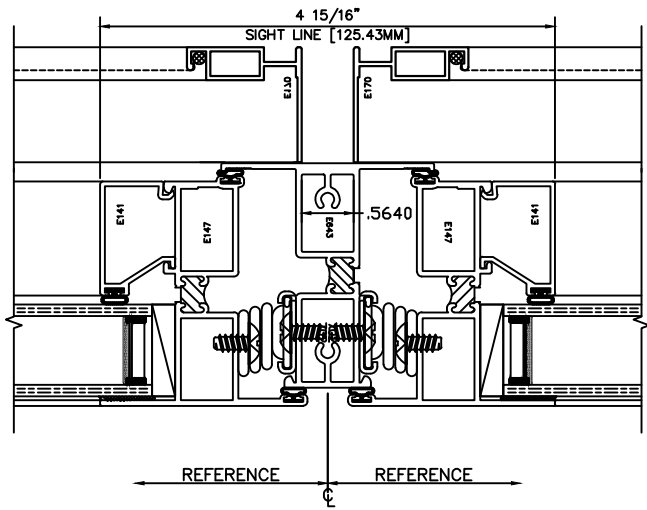

53 MTG RAIL PO/FXD

HALF SCALE DETAILS

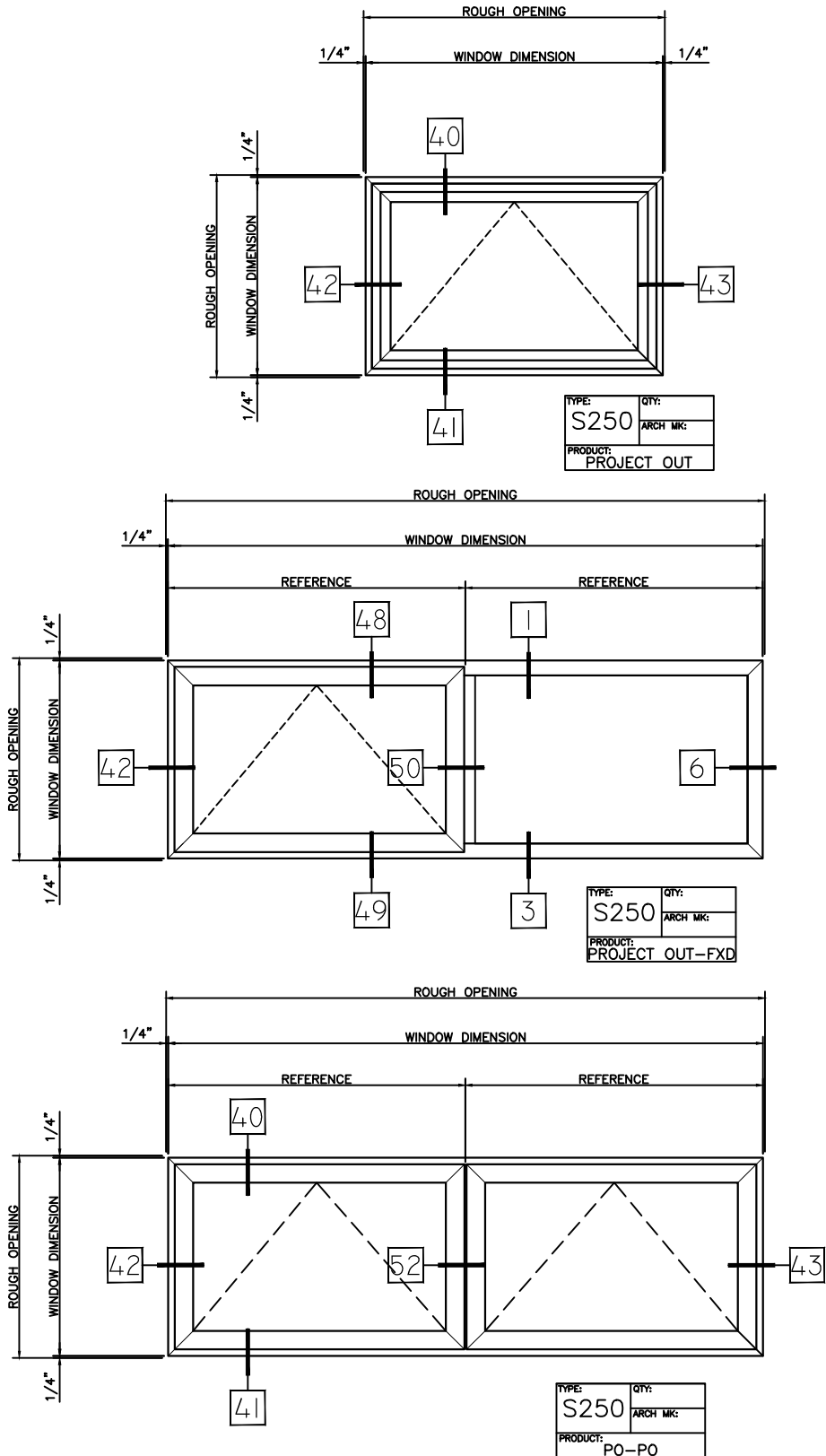

HALF SCALE DETAILS